

# Pinto

## MOVERS



A Pirrana Pinto with performance features.

# Appearance



A

## A Slotted Deep Dish Aluminum Wheels

Just what Pinto needed! Strong, handsome and light weight only 14 pounds each. Full 5 1/2" rim width improves road handling by keeping unsprung weight to a minimum. Slotted design increases air flow to brakes. Accommodates tire sizes A78 through D70 x 13. Makes Pinto a real stand out in any company. Complete with chrome hub cap, lug nuts and hardware. Bright aluminum alloy finish resists corrosion. Other 13, 14 x 15 inch sizes available upon request.

Part No. - 53144c - 13" x 5 1/2" \$47.95

## Mag Wheel Locks

Prevents mag wheels from being stolen. Locks each wheel in place till released by keys supplied. Bright finished. Attractively packaged 4 to a carton.

Part No. ML500 Set of 4 \$8.95

## Balance Weights

Stick-on type for mag wheels. Per 12 oz. strips.

Part No. WW1 \$1.75

## B Mini-Camper Kit

Slickest thing yet for the Pinto Runabout! Adds yet another use to Pinto's already long list of features. Slips on in just one minute to make Pinto an ideal over-nighter. Combined with Pirrana's PW40 "Woody" tape kit as shown makes Pinto a mini squire. Great for hunters, fishermen, campers or race track buffs. Easily sleeps two in comfort.

Part No. - P-PT \$74.88

PW-40 \$34.95



B

## C Italian Air Horns

Born on the European thoroughbreds and used in the Alps to give a powerful shrill warning to oncoming traffic. Safety is the keynote with these twin trumpet air horns, complete with compressor, air lines, hardware and instructions. Easily installed to work from your existing horn button.

Dual Plastic Trumpets Part No. - GP201 \$19.95

Dual Chrome Trumpets GC201 \$25.95

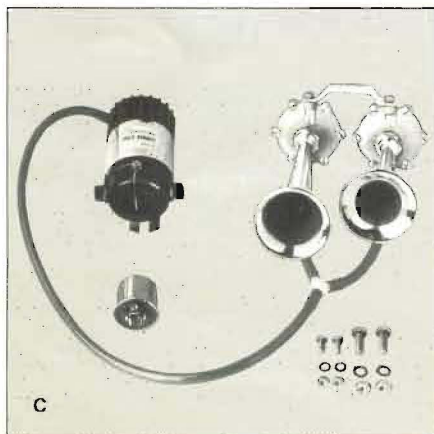

C

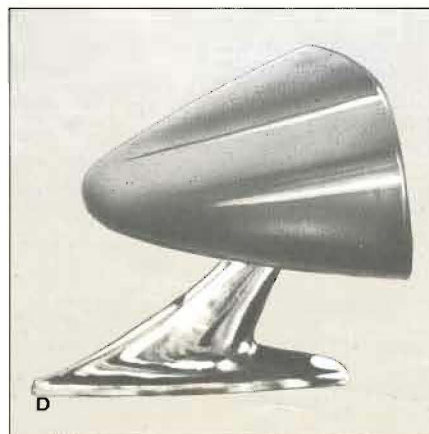

D

## D Racing Sports Mirrors

Add the sharp look of racing mirrors to your Pinto with these universal mounting sports mirrors. Finished in flat black and gleaming chrome. Easily mounted to any door sill. Looks great and provides good safe rear vision. Packaged in attractive display carton, 2 per carton.

Part No. - 390 \$19.95

# Appearance



## A Pinto GT Stripe Kits

Groovy wrap-around GT stripes designed to give the Pinto a racy flair. These stripes have been carefully and artistically designed to enhance the appearance of your Pinto and to complement the clean, sculptured lines. They are produced from pressure-sensitive vinyl material and are complete with backing paper and quality application backing to simplify application. The kit includes complete step-by-step instruction sheet and nylon applicator. These kits are easily applied and will quickly change the appearance of the Pinto from a economy sedan to a racy sports car.

**Part No. 7120W White Stripe Kit \$34.95**  
**7130B Black Stripe Kit \$34.95**

## B Finned Aluminum Valve Cover

Dress up your 2000cc Pinto engine with this Boss looking aluminum valve cover. Heavily finned to disipate heat and highly polished for lasting beauty. Heavy aluminum casting dulls valve train noise. Fits all 2000cc engines complete with gaskets, bolts, washers, oil tube, instructions and mounting hardware.

**Part No. 2010 \$51.00**

## C Rear Window Defroster

90 watt high intensity heater eliminates ice, fog and snow in a matter of minutes. Other low cost rear window devices consist of a plastic panel embodying a heating element. These panels are prone to distortion which leads to poor contact with the window and impaired visibility. The Smith's rear window heater consists of an element bonded directly to the glass thus avoiding any air gaps which reduce efficiency and vision. Low cost, easy to install on runabout, sedan, or any car. Comes complete with all necessary wiring together with switch, mounting panel, and warning light. 12 volts only.

**Part No. - RSH \$11.95**

## D Pinto Jacket Patches

Beautiful seven colour Pinto sew on patches identify you as a Pinto fan or owner. Easily applied to jackets, sweaters, coats, coveralls, shopcoats or jump suits. A real stand out and brand new. Show your colours with Pirrana's sharp new Pinto patches.

**Part No. PE1 - Oval \$1.35**  
**PE2 - Round \$1.75**

## E Finned Aluminum Timing Belt Cover

Significantly improves appearance of 2000cc engine. Matches finned aluminum valve cover and completes custom appearance desired by performance orientated Pinto owners. Cast from high grade aluminum with brightly polished fins. Easily installed complete with mounting hardware.

**Part No. - 2510 \$34.00**

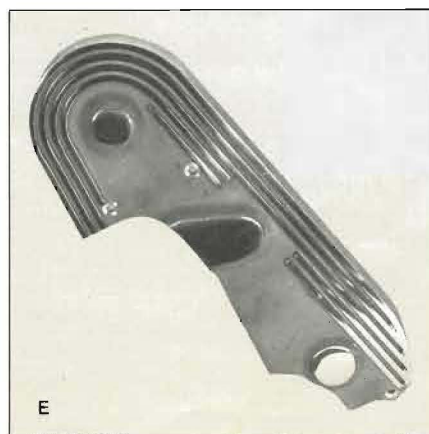
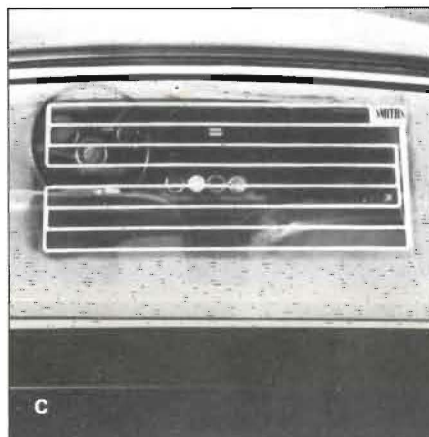
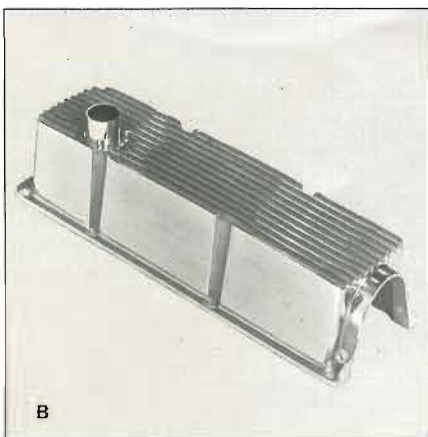

# Interior



## A Full Console

Add luxury, style, and convenience to Pinto. Formed from sturdy ABS material and complete with storage compartment under heavily padded swinging arm rest. Forward console area has large space for personal instrumentation or tape deck. Easily installed in any model of Pinto. Includes all necessary mounting hardware.

<b>4-Speed</b>	<b>Part No. - 7268</b>	<b>\$69.95</b>
<b>Automatic</b>	<b>7269</b>	<b>\$69.95</b>

## Steering Wheels

Add class and sports car styling with these imported steering wheels available in three different designs. Each wheel installed in minutes because of exclusive easy mounting hub design, with no loose pieces to complicate installation. Horn button mounts in centre. The finest quality steering wheel available anywhere.

**B Montevideo** (shown) Here is the top of the line. 13" diameter gives lots of extra knee room. Covered with genuine imported leather with multiple finger grips on reverse side. Aluminum spokes stamped from a single sheet produce one piece design with no rivets or welds. Spokes and hardware are black anodized to minimize glare reflection. Black crinkle mounting hub.

**Part No. - 43400**      **\$59.95**

**C Puma HF** (shown) Imported leathers are used on this one. Brushed aluminum spokes. Multiple finger grips on the reverse side. Black anodized bolts give rugged appearance. 14" diameter.

**Part No. - 48000**      **\$59.95**

**Autostrata** Made from the finest natural polished walnut with bright polished aluminum spokes formed from a single sheet of high tensil aluminum, no rivets or welds to break or come loose. Semi dished 15" diameter.

**Part No. - 38200**      **\$47.95**

## D Gear Shift Knobs

Give your Pinto that GT feel with Pirrana's new gear shift knobs. Considerably bigger than the original hard rubber knob in diameter. These knobs provide a European GT flair as well as the gutsy feel as you swing Pinto through the gears. Available in real reflective walnut or genuine imported leather, both have distinctive Pinto emblems on top. Easily installed, packed 1 to a carton. For Automatic owners there is a real Walnut T-Bar shift knob with reverse lock out button.

<b>Part No. - 8327-82</b>	<b>Leather</b>	<b>\$6.95</b>
<b>8400</b>	<b>T-Bar</b>	<b>\$6.95</b>
<b>8227-82</b>	<b>Walnut</b>	<b>\$5.50</b>

## E Steering Wheel Covers

Beautifully styled imported vinyl steering wheel covers enhance appearance of any car. Cushioned with heavy foam padding, giving sports car feel and solid slip free control of the wheel. Attractively display packaged in 3 colours.

<b>Part No. - 102</b>	<b>Red</b>	
<b>105</b>	<b>Tan</b>	<b>\$6.95</b>
<b>107</b>	<b>Black</b>	

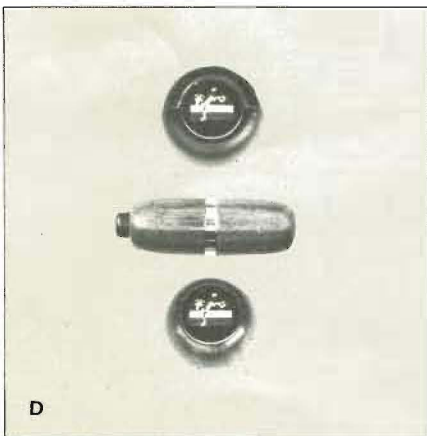
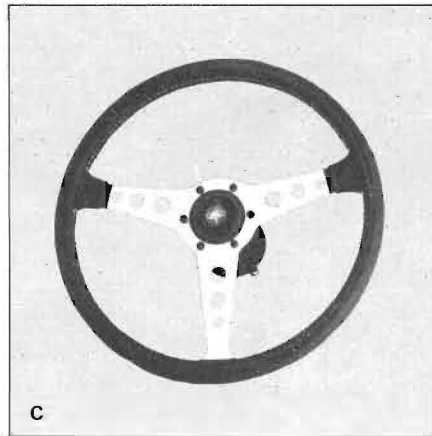

# Instruments



## A Tachometer — 80mm

The first basic instrument needed in getting the most from Pinto. Fits both 1600cc and 2000cc engines and manufactured by Smith's, one of the most trusted names in the world of instrumentation. A must for the driver who takes pride in his driving. Internally illuminated, black faced with white numerals and fully adjustable red line. Easily installed, can be mounted in Pirrana's custom console. Choice of black crinkle or brushed aluminum cases. Large 80mm (3") face.

Part No. KP2504-00 \$39.95

## Custom Tachometer Housings

Non-glare black crinkle finished housing for above. Bright finished brushed aluminum housing for above.

Part No. KP2501-02 Black \$5.95

KP2501-01 Aluminum \$5.95

## B Tachometer — 60mm — Self Mounting

A high quality instrument designed to give years of reliable service. Mounts directly through dash or console. All wiring is fed through centre pedestal and out of sight. Mount with single hole in dashboard or console. Comes complete with attractive black case. Specifications similar to above but 60mm diameter (2 1/2") and less adjustable red line. Fully illuminated.

Part No. - RVI5000-00 \$39.95

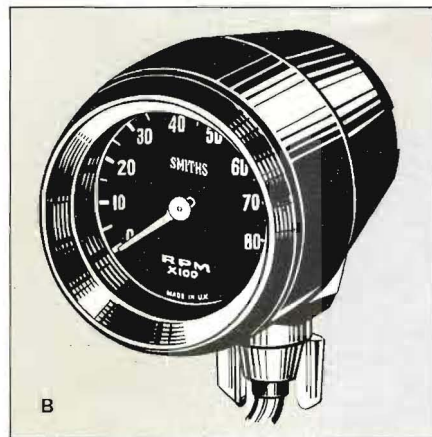

## C Water Temperature Gauge

Keep a wary eye on your engine temperature with this Smiths water temperature gauge. Calibrated from 90-230°. Warns of impending trouble such as: incorrectly set timing, defective thermostat, low water level etc. 300° sweep gives precise accurate water temperature readings. One of the best instruments money can buy. Black faced with white numerals and chrome bezel measure 2-13/64" diameter. Fully illuminated and complete with 6" capillary tube.

Part No. TG1301-03 \$16.60

## D Oil Pressure Gauge

Oil pressure is vital and perhaps the most important instrument one can have in the dash. Oil is the engine's life blood. Incorrect oil pressure can forewarn you of expensive mechanical defects. Finish is black faced with white numerals, 300° sweep, fully illuminated, 2-13/64" diameter complete with all fittings and piping necessary for installation. Calibrated in 0-100 lbs., 0-160 lbs.

Part No. PG1301-00 0-100 lbs. \$13.95

PG1301-07 0-160 lbs. \$13.95

## T-Piece Adaptor for Oil Gauges

This T-piece is necessary when connecting both oil pressure warning light and oil pressure gauge to the same block outlet.

Part No. SNA 10370 \$3.90

## E Battery Condition Indicator

Sensitive volt meter designed to give advanced warning of battery failure. Gives warning of low charge rate or excessively high voltage output, each condition resulting in dead battery. Calibrated to give accurate reading, complete with illuminated dial and installation instructions.

12 Volt Part No. KP9300-00 \$8.50

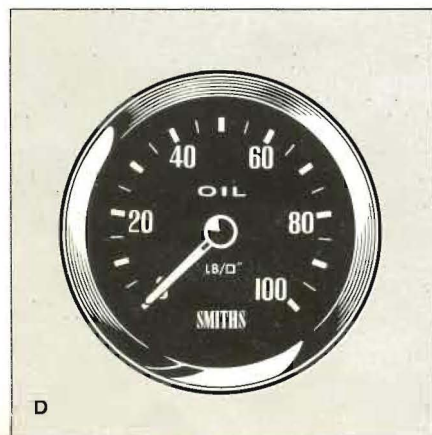
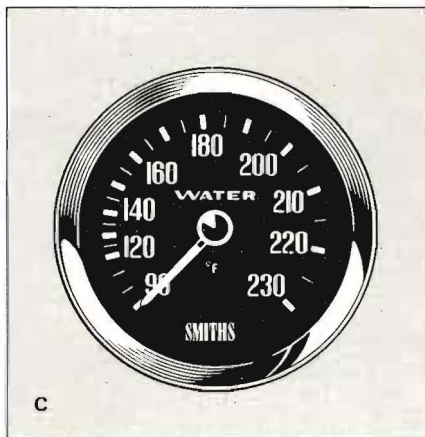

# Performance

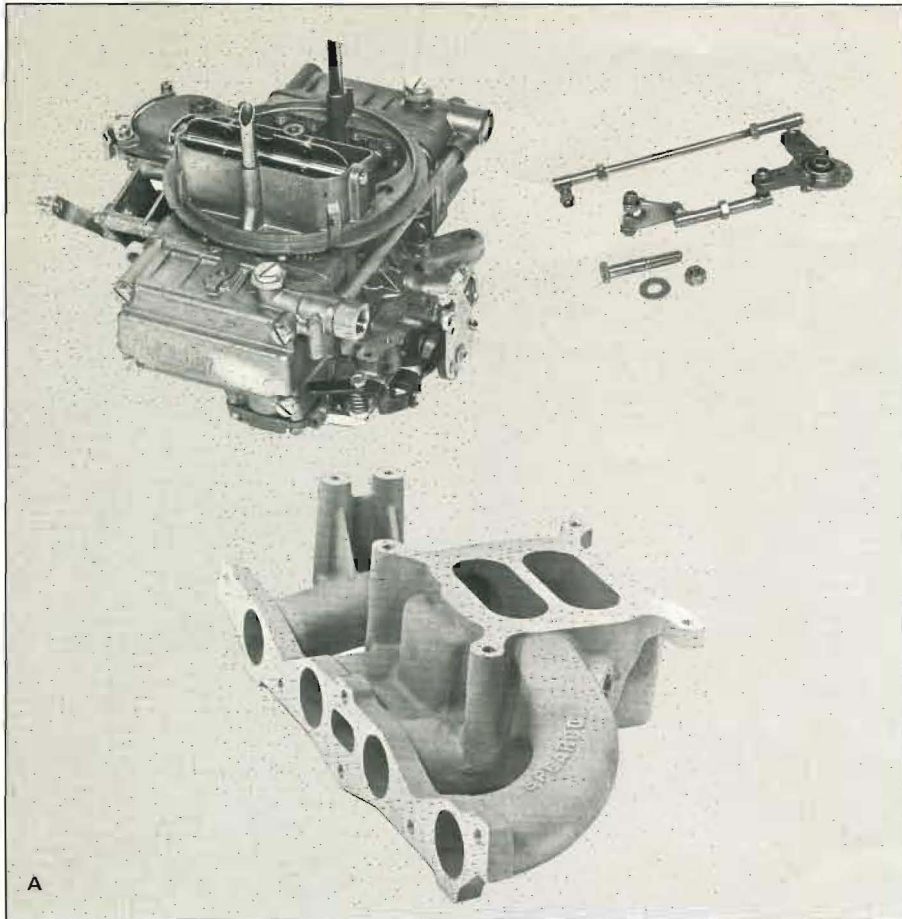

## A Four Barrel Induction Kit

Specially designed for the 2000cc Pinto, Capri and Cortina engine, this is the one that makes it happen. Kit comes complete with 4V equal length aluminum intake manifold tuned for maximum power output. This manifold is complete with all connections for emission control hook up, including the de-acceleration valve. Working closely with Holly carburetor engineers we have developed a special four barrel carburetor featuring specially calibrated orifice sizing and reverse power valve. Special float hardware is provided to cope with the high speed vibration inherent in four cylinder engines. Optimum 390 CFM capacity carburetor equipped with manual choke (cable not supplied with kit) provides economy and yet plenty of punch. Also included is special ball bearing bell crank linkage permanently lubricated and sealed. Designed to adapt to either four speed or automatic transmission linkage, comes with miscellaneous hardware fittings and gaskets necessary for installation.

**Part No. 4810 \$197.65**

## B Sports Muffler

This sports muffler really gets the job done. Improves HP and economy by up to 5%. Gives Pin to a deep throaty sound of power. Twin chrome outlets add dash-ing style. Optimum power output produced when used with Pirrana headers, but may be used alone. Easily installed with clamps supplied.

**Part No. NPN \$39.95**

## C Headers

The absolute first step in improving Pinto's performance. Increases HP by up to 12%. Increases economy and performance by vastly improving exhaust efficiency. Lets the engine produce all the power it already has by individually tuning each individual exhaust port for maximum output. Superior four into one design developed in conjunction with extensive dynamometer testing. Headers are nickel plated for lasting appearance and are packaged complete with reducer, gaskets and all necessary mounting hardware.

**Part No. 5141 (1600cc) \$74.95**  
**5142 (2000cc) \$74.95**

## D Electronic Ignition

The biggest advancement in automotive ignitions in years. Adds performance and economy plus to all 1600 and 2000cc engines. Reduces current through points to 1/10 of an Amp from normal 7-8 Amps. Vastly reduces point bounce and wear. Provides a high intensity precision spark to well beyond the usable RPM range to either engine. Improves fuel economy, provides easier starting and reduces maintenance and increases power output. Virtually eliminates fouled plugs. Full 5 year guarantee.

**Part No. C20 Electronic ignition \$59.95**

Tachometer adaptor to use current impulse tachs, such as Smith's with electronic ignition.

**Part No. TPC-1A \$ 6.85**

## E Traction Bars

Engineered to do away with wheel hop and chatter on hard acceleration or braking caused by excessive rear spring wind up. Mounts easily to rear axle u-bolts. Finished in attractive white enamel. A must for any type of hard driving. Packaged 2 per box. Complete with all necessary hardware for installation.

**Part No. 5500A \$36.89**

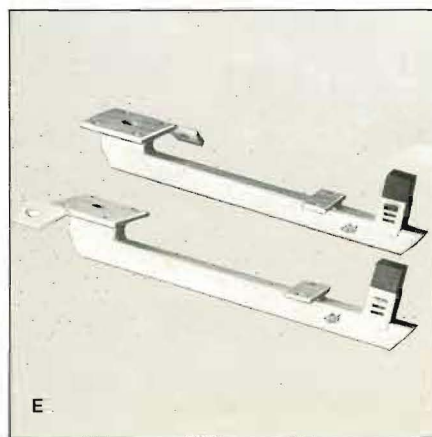
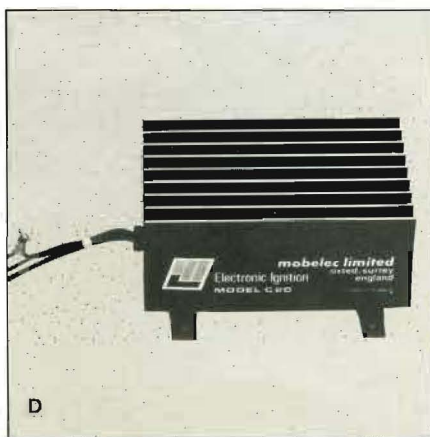
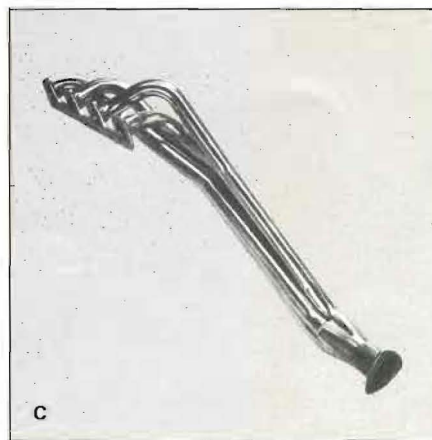
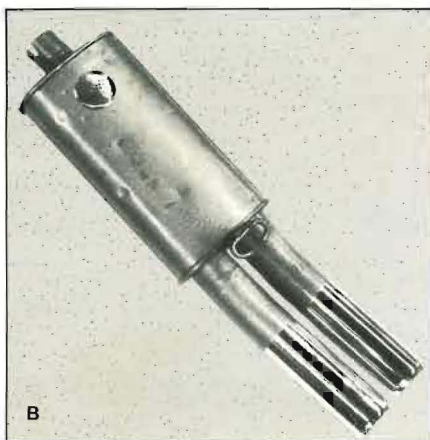

# Performance

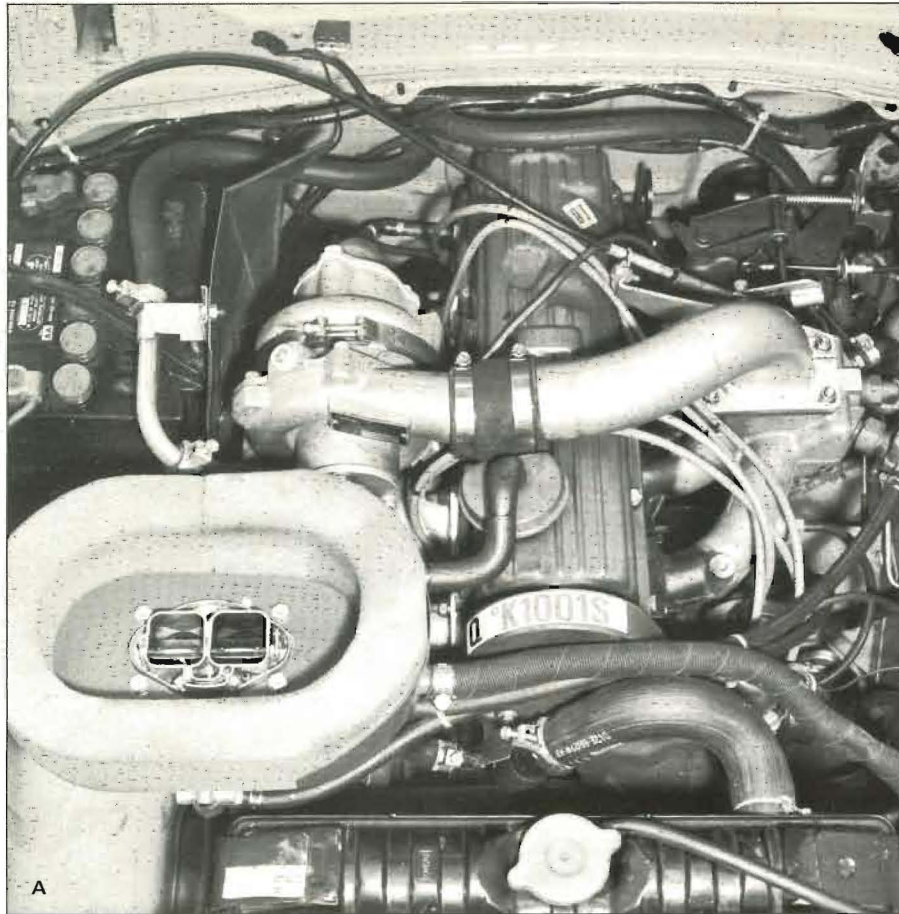

## A/B Turbocharger Kit

Bolt on 60 extra HP with this fantastic turbocharger kit. Makes your 2000cc Pinto run like a V8 and still get up to 25 miles per gallon. Here's how it works: Engine exhaust gasses which normally pass through the exhaust pipe are routed instead into the turbocharger, through a specially-cast exhaust manifold. The exhaust gasses drive the primary side of the turbine — at speeds up to 100,000 RPM — and are routed back into the Pinto exhaust system. A shaft connects the primary side of the turbine to the secondary of compressor turbine which draws fuel and air from the carburetor compresses it, and on driver demand, forces it under pressure to the stock intake manifold and into the cylinders, resulting in up to 60 extra HP. Bolts completely on the outside of the engine. No need to go inside. Turbine unit is fed pressurized oil from oil galleries and returns back directly to the pan. Performance is fantastic. Plenty of punch for passing and accelerating on freeways. Complete with everything except tools necessary to install including, steering column mounted vacuum/pressure gauge. The ultimate value for your performance dollar. Installation time averages 6 hours. Approx. Shipping weight, 40 lbs.

**Part No. P-26-KS-4 speed transmission \$529.95**  
**P-26-KA-Automatic transmission \$542.50**

## C Cibie Quartz Iodine Driving Lights Type 35

Cibie lighting is used exclusively by the Ford of Europe world cup winning Rally champions. This new Cibie Type 35 is designed to mount where no other lamp will fit. Extra thin, with a 110° swivel mount makes for easy grill mounting. Pure white high intensity beam of 300,000 candle power provides unsurpassed light penetration for safer and more relaxed driving. Available in amber fog or clear lens driving. Constructed of 100% stainless steel and completely water resistant.

**Part No. 4209022/12 Long range clear \$29.95**  
**4209016/12 Fog Amber \$29.95**  
**H212 Replacement bulb \$ 7.50**

## D Front and Rear Sway Bars

Turns Pinto into a top handling sporty machine. Vastly reduces body lean and increases traction on hard cornering. Keeps Pinto up with the best of the imported cars on the road today, when coupled with Pirrana's Koni shock option. Changes mild to wild! Reduces sway and pitching resulting in more precise control. Fabricated from 4130 alloy steel with aircraft type rod ends insuring endurance and precision. Complete with all necessary hardware, Bars may be installed individually but for maximum effect should be used as a set.

**Part No. 5012 Front 3/4" \$48.00**  
**5022 Rear 5/8" \$50.00**

## E Koni Competition Shocks

The worlds best known competition shock used by the best competition drivers. When combined with Pirrana's sway bars these shocks are what you need to put your Pinto into the top handling European car class. Fully adjustable Konis should never require replacement, as any future wear that takes place after many tens of thousands of miles, can be easily corrected by adjusting the Konis and bringing the damping forces back to their original efficiency. Because of this unique feature, Konis are your cheapest investment per mile.

**Part No. 80A2166 Front \$23.94**  
**80-2167 Rear \$22.68**

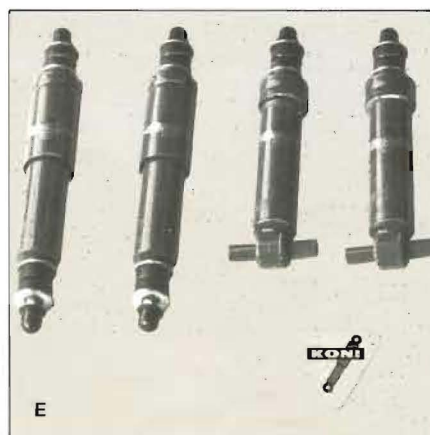
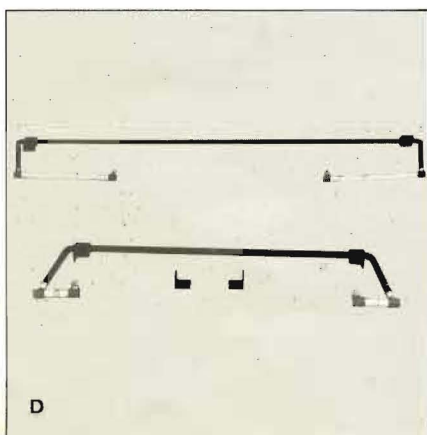
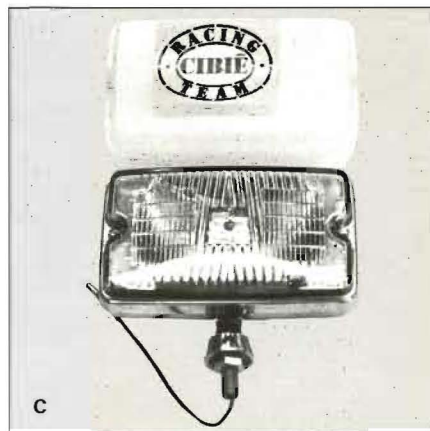
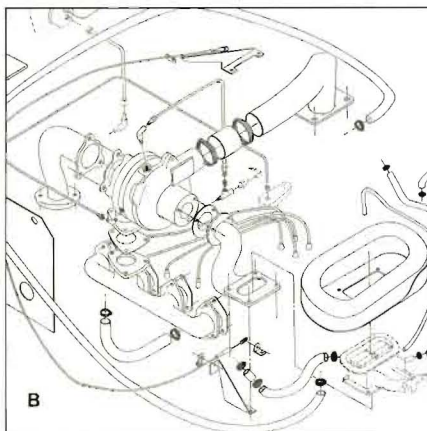

# SPECIAL PACKAGES

Here's your chance to buy a special Pirrana Pinto package and save!

## Formula Package 10

(Specify Trans. Engine and Tape Colour)

Console	\$ 69.95
Tape Stripe Kit	34.95
Steering Wheel Cover	6.95
Walnut Shift Knob	5.50
	<u>\$117.35</u>
Special pkg. discount	11.74
Total pkg. price	<u>\$105.61</u>

## Hot Wheels Package 30

(Specify Tape & Wheel Cover Colour)

Mag Wheels (4)	\$191.80
Tape Stripe Kit	34.95
60mm Tachometer	39.95
Steering Wheel Cover	6.95
Walnut Shift Knob	5.50
	<u>\$279.15</u>
Special pkg. discount	27.91
Total pkg. price	<u>\$251.24</u>

## Pirranas Decal

Available now Pirrana's big new 3" x 6" four colour "eats 'em up" decal send 50 cents plus tax for this original

## Rally Sports Special Package 20

(Specify Engine Lens and Wheel Cover Colour Desired)

Cibie Lights (2)	\$ 59.90
Koni Shocks (4)	93.24
Steering Wheel Cover	6.95
60mm Tachometer	39.95
Walnut Shift Knob	5.50
Headers	74.95
	<u>\$280.49</u>
Special pkg. discount	28.05
Total pkg. price	<u>\$252.44</u>

## Pirrana Pinto Package 40

(Specify Tape, Engine & Wheel Cover Colour)

Mag Wheels (4)	\$191.80
Headers	74.95
Muffler	39.95
Tape Stripe Kit	34.95
60mm Tachometer	39.95
Air Horns (plastic)	19.95
	<u>\$401.55</u>
Special pkg. discount	40.15
Total pkg. price	<u>\$361.40</u>

Should you require further special assistance on our product lines please do not hesitate to phone or write.

# PIRRANA



T.M.

## PIRRANA PERFORMANCE PRODUCTS

P. O. BOX 158 PORT CREDIT, MISSISSAUGA, ONTARIO, CANADA (416) 278-2453